

Manufacturer	Fixture	ArtNET Universe	Address	Mode
Martin	Mac Quantum Profile	1	1	Extended
Martin	Mac Quantum Profile	1	28	Extended
Martin	Mac Quantum Profile	1	55	Extended
Martin	Mac Quantum Profile	1	82	Extended
Martin	Mac Quantum Profile	1	109	Extended
Martin	Mac Quantum Profile	1	136	Extended
Martin	Mac Quantum Profile	1	163	Extended
Martin	Mac Quantum Profile	1	190	Extended
Martin	Rush MH 6 Wash	2	1	14 DMX
Martin	Rush MH 6 Wash	2	15	14 DMX
Martin	Rush MH 6 Wash	2	29	14 DMX
Martin	Rush MH 6 Wash	2	43	14 DMX
Martin	Rush MH 6 Wash	2	57	14 DMX
Martin	Rush MH 6 Wash	2	71	14 DMX
Clay Paky	Axcor Beam 300	3	1	Sharp, 16 DMX
Clay Paky	Axcor Beam 300	3	17	Sharp, 16 DMX
Clay Paky	Axcor Beam 300	3	33	Sharp, 16 DMX
Clay Paky	Axcor Beam 300	3	49	Sharp, 16 DMX
Clay Paky	Axcor Beam 300	3	65	Sharp, 16 DMX
Clay Paky	Axcor Beam 300	3	81	Sharp, 16 DMX
Clay Paky	Axcor Beam 300	3	97	Sharp, 16 DMX
Clay Paky	Axcor Beam 300	3	113	Sharp, 16 DMX
Martin	Atomic 3000	3	129	4 Channel
Martin	Atomic 3000	3	133	4 Channel
Martin	Atomic 3000	3	137	4 Channel
Martin	Atomic 3000	3	141	4 Channel
Martin	Atomic 3000	3	145	4 Channel
Martin	Rush MH 6 Wash LX3	3	153	14 DMX
Martin	Rush MH 6 Wash LX3	3	167	14 DMX
CLF	Hercules LX3	3	200	12 DMX
CLF	Hercules LX3	3	212	12 DMX
Robe	ParFect 100	4	1	Mode 4
Robe	ParFect 100	4	31	Mode 4
Robe	ParFect 100	4	61	Mode 4
Robe	ParFect 100	4	91	Mode 4
Robe	ParFect 100	4	121	Mode 4
Robe	ParFect 100	4	151	Mode 4
Robe	ParFect 100	4	181	Mode 4
Robe	ParFect 100	4	211	Mode 4
Robe	ParFect 100	4	241	Mode 4
Robe	ParFect 100	4	271	Mode 4
Robe	ParFect 100	4	301	Mode 4
Robe	ParFect 100	4	331	Mode 4
Robe	ParFect 100	4	361	Mode 4
Robe	ParFect 100	4	391	Mode 4
Robe	ParFect 100	4	421	Mode 4
Robe	ParFect 100	4	451	Mode 4
CLF	Hercules	5	1	12 DMX
CLF	Hercules	5	13	12 DMX
CLF	Hercules	5	25	12 DMX
CLF	Hercules	5	37	12 DMX
CLF	Hercules	5	49	12 DMX
ETC	Source Four Revolution	5	61	front BLANK, rear BLANK
CLF	Hercules	6	1	12 DMX
CLF	Hercules	6	13	12 DMX
CLF	Hercules	6	25	12 DMX
CLF	Hercules	6	37	12 DMX
CLF	Hercules	6	49	12 DMX
Generic	2kw Front 1	7	1	Dim
Generic	2kw Front 2	7	2	Dim
Generic	2kw Front 3	7	3	Dim
Generic	Dimmer	7	4	Dim
Generic	Dimmer	7	5	Dim
Generic	Dimmer	7	6	Dim
Generic	Dimmer	7	7	Dim

Generic	Dimmer	7	8	Dim
Generic	Profile 1	7	9	Dim
Generic	Profile 2	7	10	Dim
Generic	Profile 3	7	11	Dim
Generic	Profile 4	7	12	Dim
Generic	Profile 5	7	13	Dim
Generic	Profile 6	7	14	Dim
Generic	Profile 7	7	15	Dim
Generic	Profile 8	7	16	Dim
Generic	2kw LX5 1	7	17	Dim
Generic	2kw LX5 2	7	18	Dim
Generic	2kw LX5 3	7	19	Dim
Generic	Dimmer	7	20	Dim
Generic	Dimmer	7	21	Dim
Generic	Dimmer	7	22	Dim
Generic	Dimmer	7	23	Dim
Generic	Dimmer	7	24	Dim
Generic	2Kw Blinder 1	7	25	Dim
Generic	2Kw Blinder 2	7	26	Dim
Generic	Dimmer	7	27	Dim
Generic	Dimmer	7	28	Dim
Generic	Dimmer	7	29	Dim
Generic	Dimmer	7	30	Dim
Generic	Dimmer	7	31	Dim
Generic	Dimmer	7	32	Dim
Generic	2kw Worklights	7	33	Dim
Generic	2kw Worklights	7	34	Dim
Generic	2kw Worklights	7	35	Dim
Generic	2kw Worklights	7	36	Dim
Generic	2kw Worklights	7	37	Dim
Generic	2kw Worklights	7	38	Dim
Generic	2x 1Kw LX6	7	39	Dim
Generic	Profile LX 6	7	40	Dim
Generic	Stage Dimmers	7	41	Dim
Generic	Stage Dimmers	7	42	Dim
Generic	Stage Dimmers	7	42	Dim
Generic	Stage Dimmers	7	43	Dim
Generic	Stage Dimmers	7	44	Dim
Generic	Stage Dimmers	7	45	Dim
Generic	Stage Dimmers	7	46	Dim
Generic	Stage Dimmers	7	47	Dim
Smoke Factory	Tour-Hazer II SR	7	501	2 DMX
Smoke Factory	Tour-Hazer II SL	7	501	2 DMX

Console:	ArtNET IP Address:
House Tiger Touch II	2.161.57.250
House Quarts	2.161.57.251
Headliner	2.161.57.252
Support	2.161.57.253

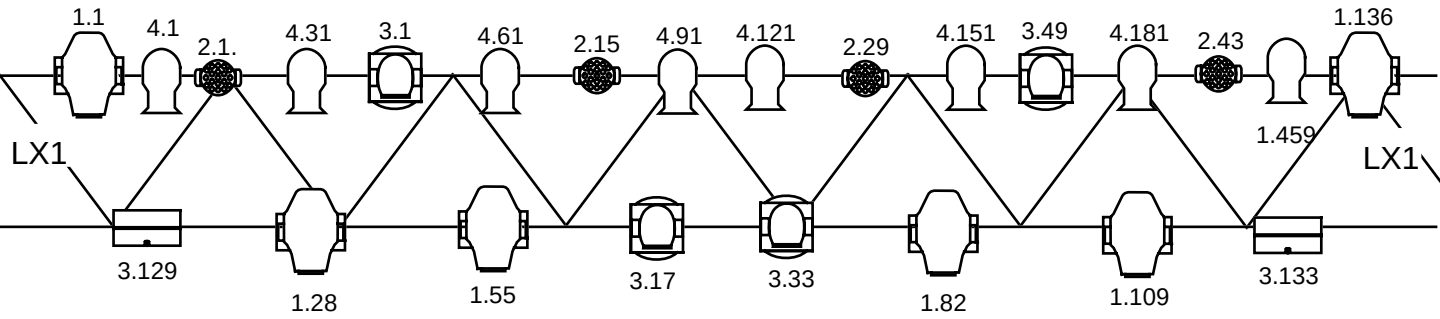

Smoke Factory Tour Hazer II
7.501

Smoke Factory Tour Hazer II
7.501

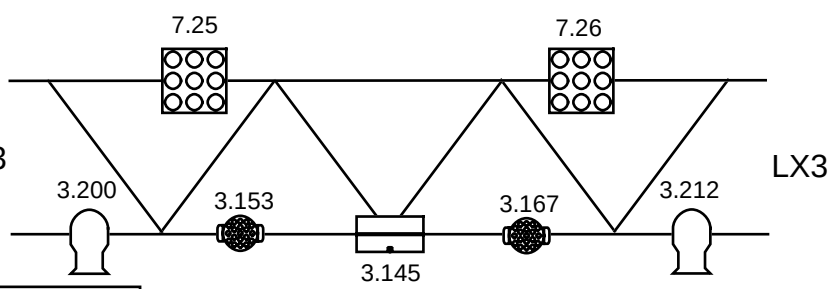
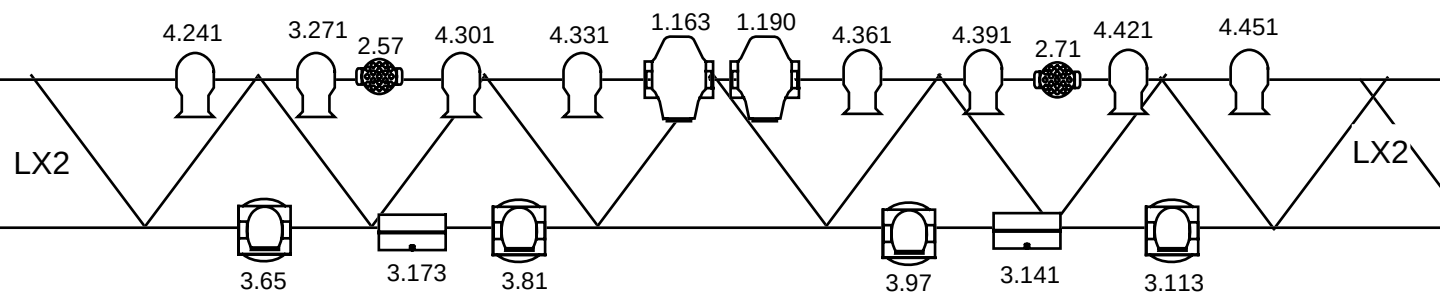

Key

Channel



Rush MH6



Mac Quantum Profile



Atomic 3000



Axcore 300 LED Beam



2Kw Blinder



Robe Perfect 100

Grote zaal

Stage

Venue:

Q-Factory

Designer:

A. Van Oorspronk

10/27/19

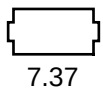
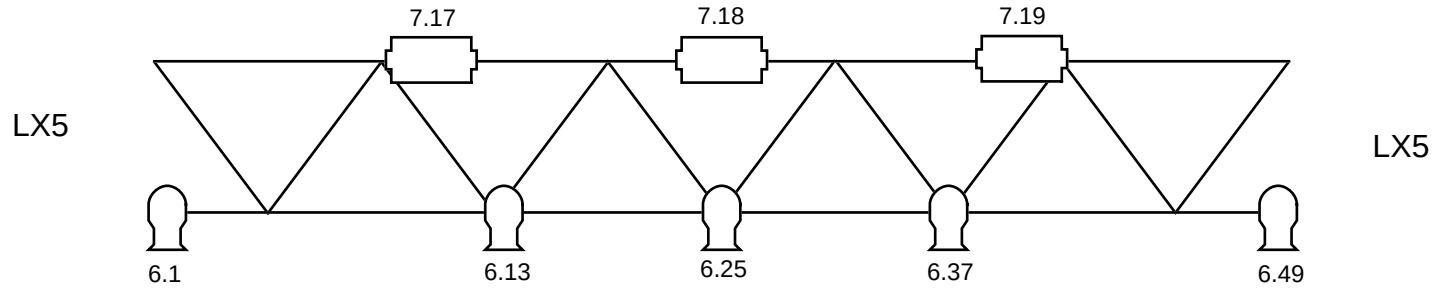
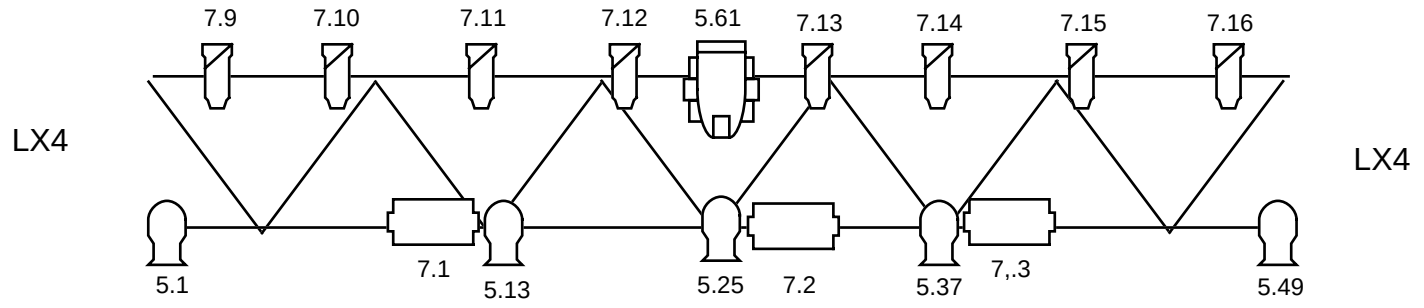
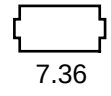
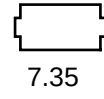
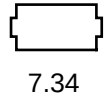
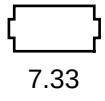

LX 6

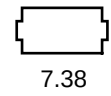
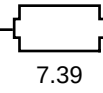
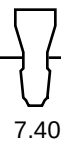
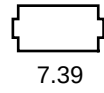

Key

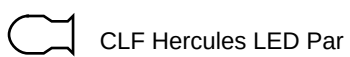
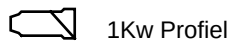
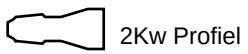
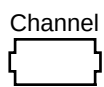

Grote Zaal

Dance Floor

Venue: Q-Factory

Designer: A.Van Oorspronk

10/27/19